

HONDA RC211V (MotoGP 2002 2003)

[TAMIYA 1/12 Honda RC211V MotoGP 対応]

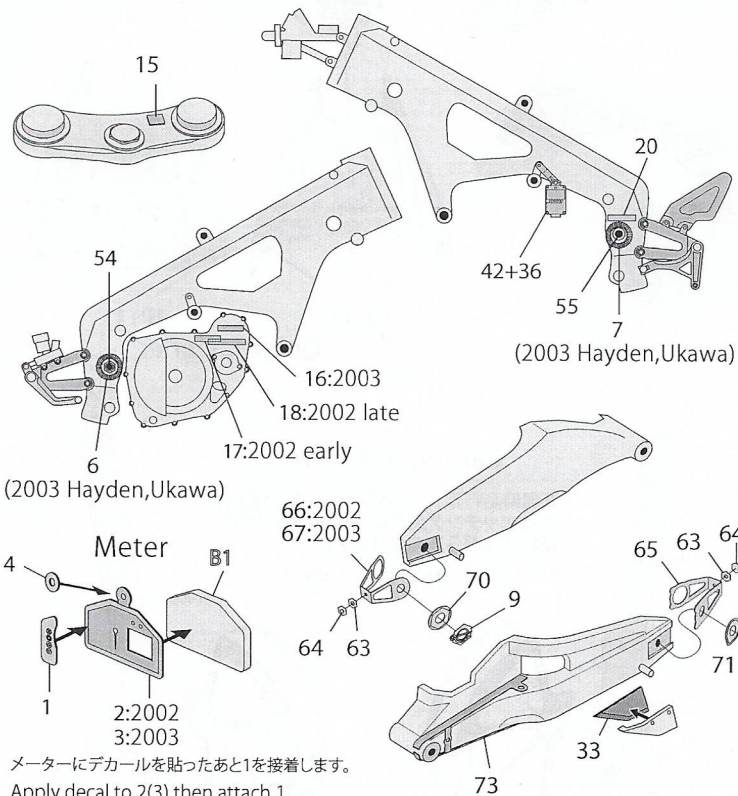

Brake pedal

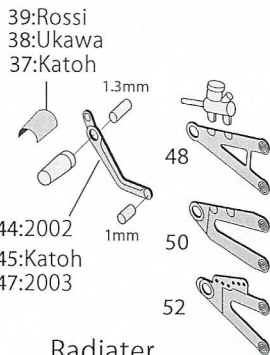

Change pedal

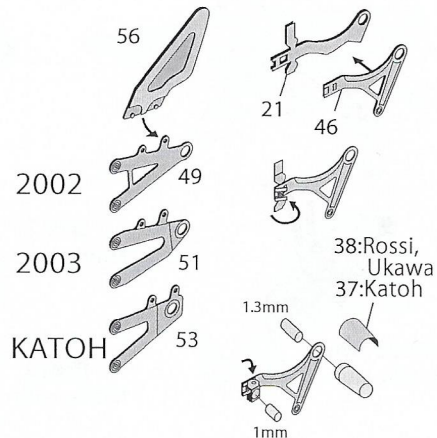

Radiator

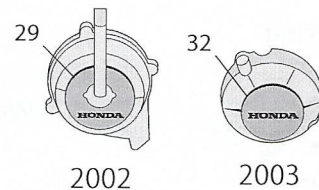
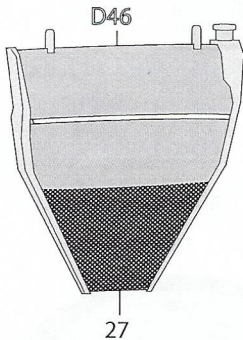

Clutch

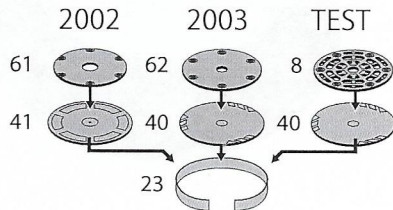

Rear brake disk

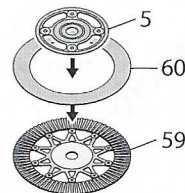

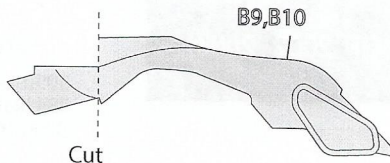
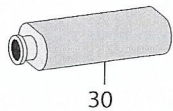
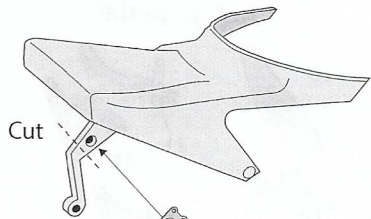

Antenna

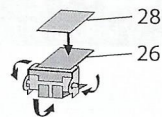

24:2002 early
25:2002 late

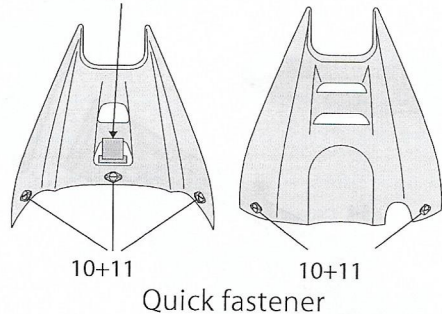
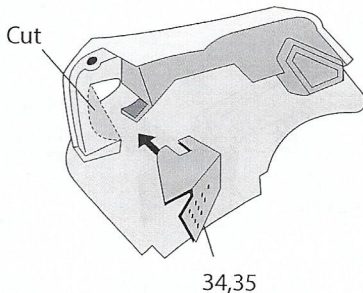
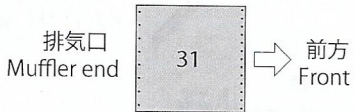
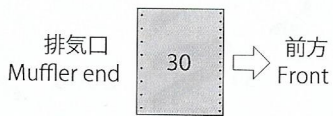
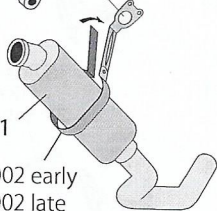

Exhaust spring

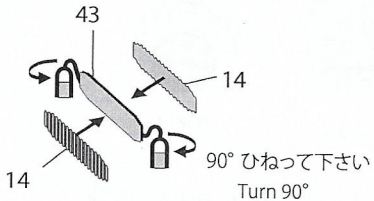

Wheel balance weight

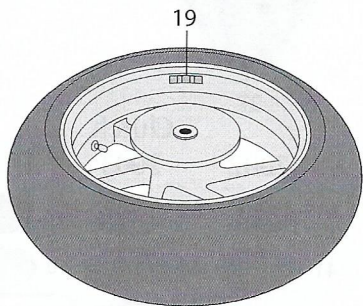

Carbon disk cover

低温時走行用、カーボンディスクの保温カバー
22はエッチング余白についているジグに
合わせながら湾曲させます。
Bend 22 along to jig of the sheet A.

