

© 2008 - 2009, Birger de la Peña. All rights reserved.

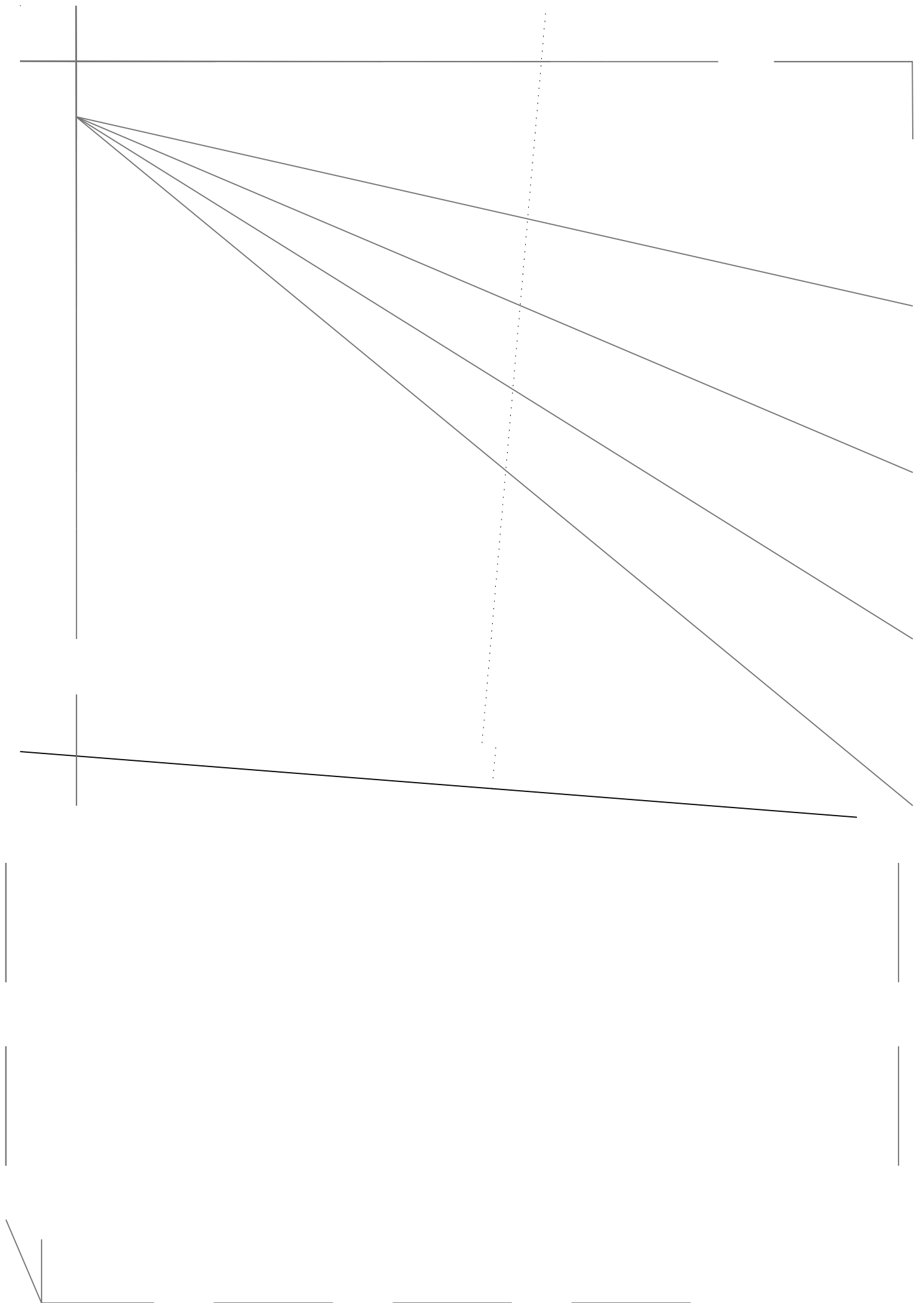

**Foam Sheet A**  
3mm Depron Foam

Model: MX Aircraft, MXS  
Scale: 1/74 Wingspan  
Design: Birger de la Peña

NOTE: Some assemblies require two double-sided adhesive.

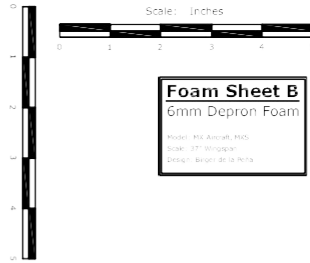
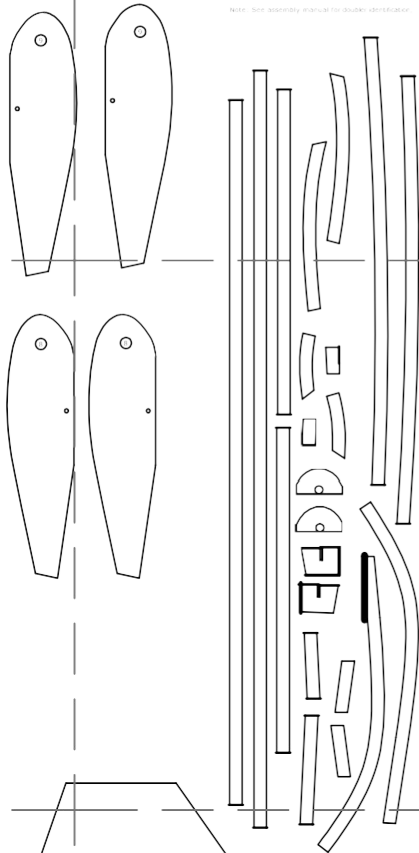

**Foam Sheet B**  
6mm Depron Foam

Model: MX Aircraft, MXS  
Scale: 1/74 Wingspan  
Design: Birger de la Peña

**MXS**  
37" Wingspan  
Depron Construction  
Birger de la Peña  
bdelapen@gmail.com

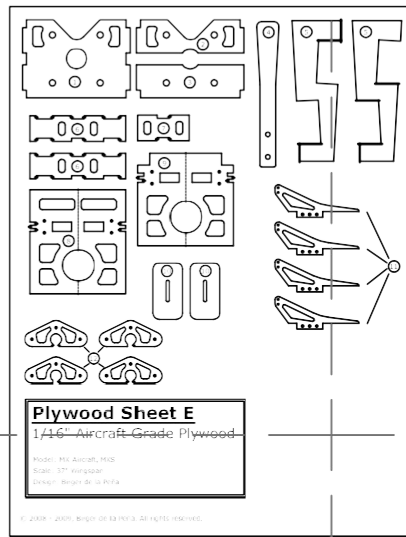

**Plywood Sheet E**  
1/4" Aircraft-Grade Plywood

Model: MX Aircraft, MXS  
Scale: 1/74 Wingspan  
Design: Birger de la Peña

© 2008 - 2015, Birger de la Peña. All rights reserved.

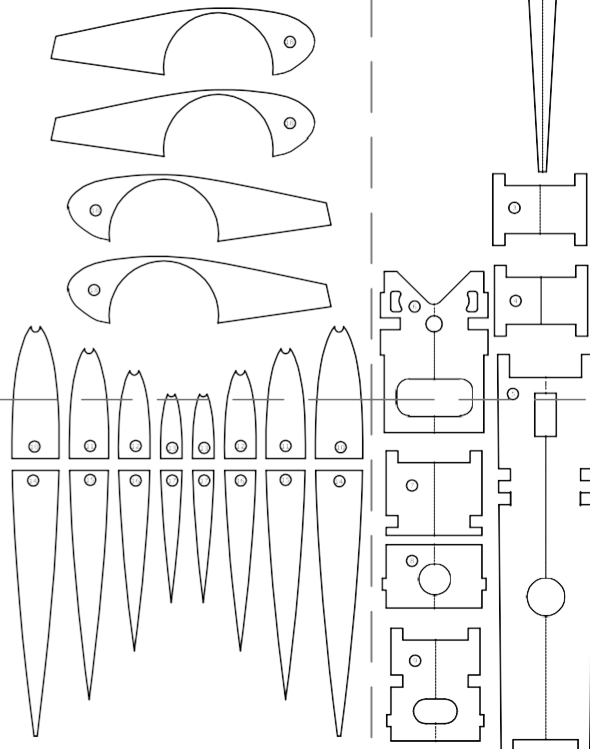

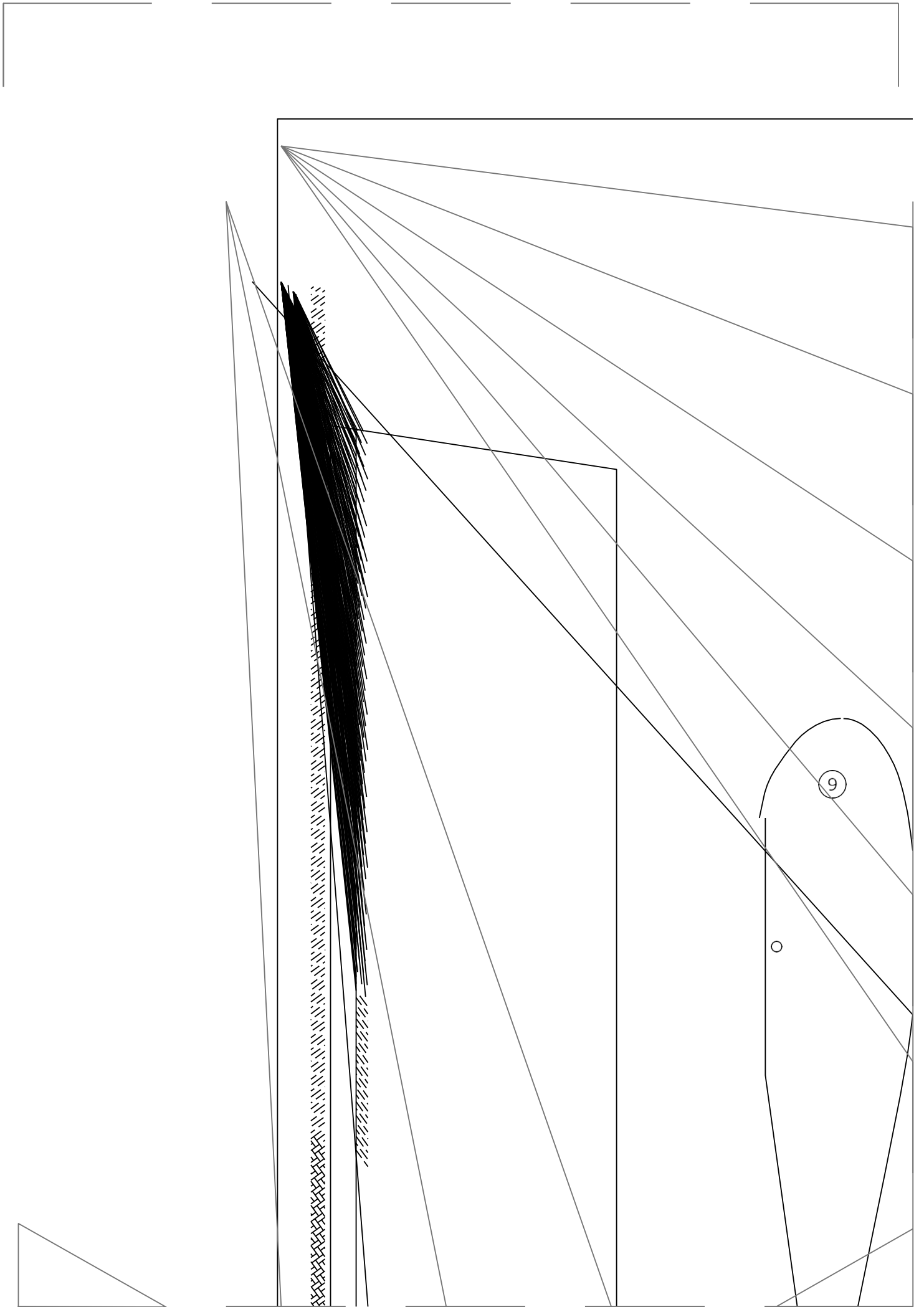

# Foam Sheet A

## 3mm Depron Foam

Model: MX Aircraft, MXS

Scale: 37" Wingspan

Design: Birger de la Peña

Note: See assembly manual for doubler identification.

9

○

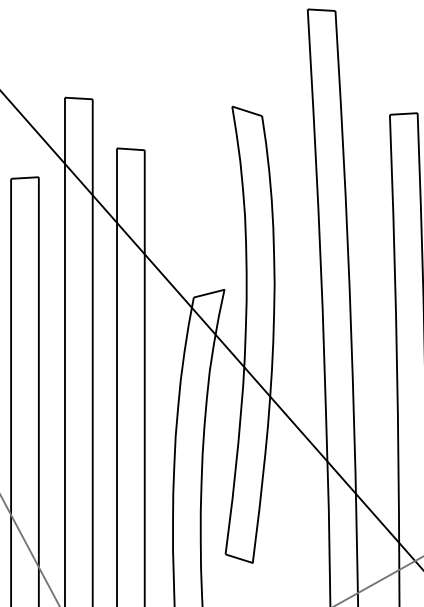

Scale: Inches



## Foam Sheet B

6mm Depron Foam

Model: MX Aircraft, MXS

Scale: 37" Wingspan

Design: Birger de la Peña

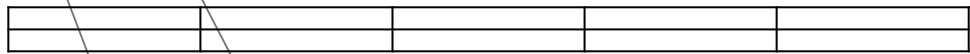
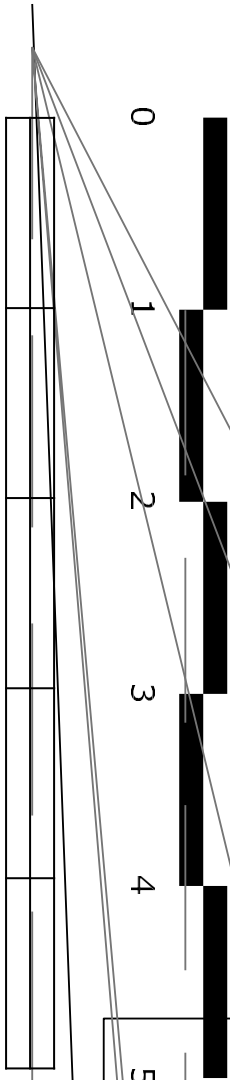

# MXS

37" Wingspan

Depron Construction

Birger de la Peña  
bdelapen@gmail.com